

ABOVE CEILING AHU SUSPENSION ARRANGEMENT
NOT TO SCALE

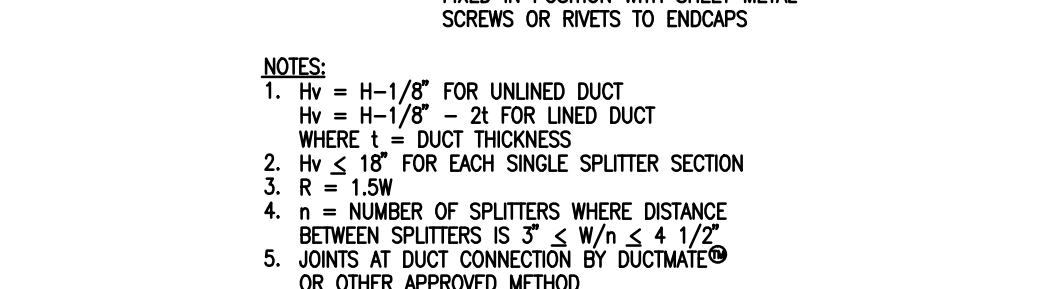

VANED RECTANGULAR SHEETMETAL ELBOWS
NOT TO SCALE

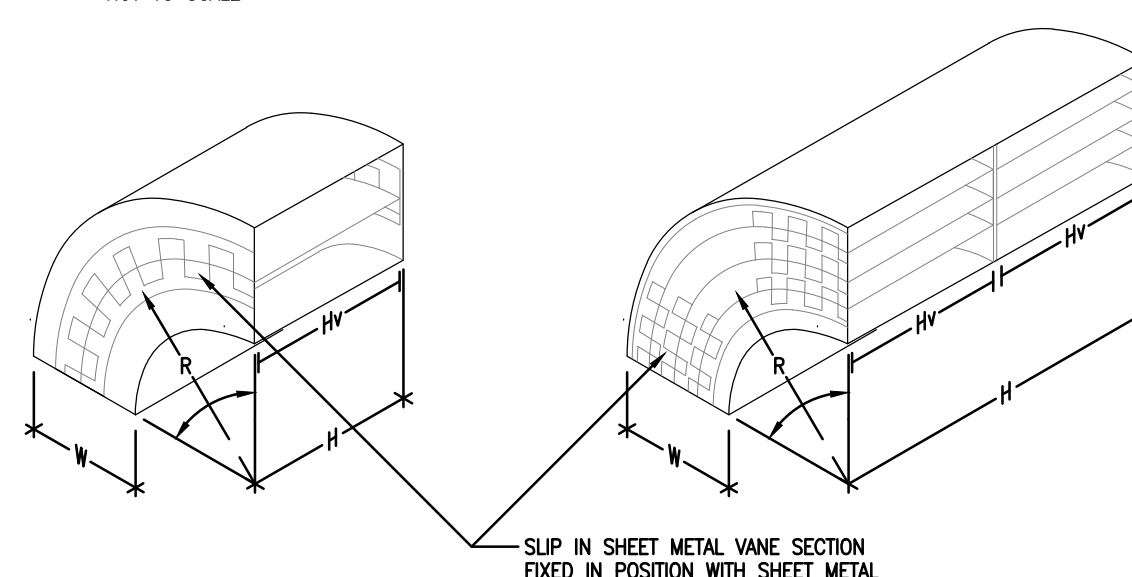
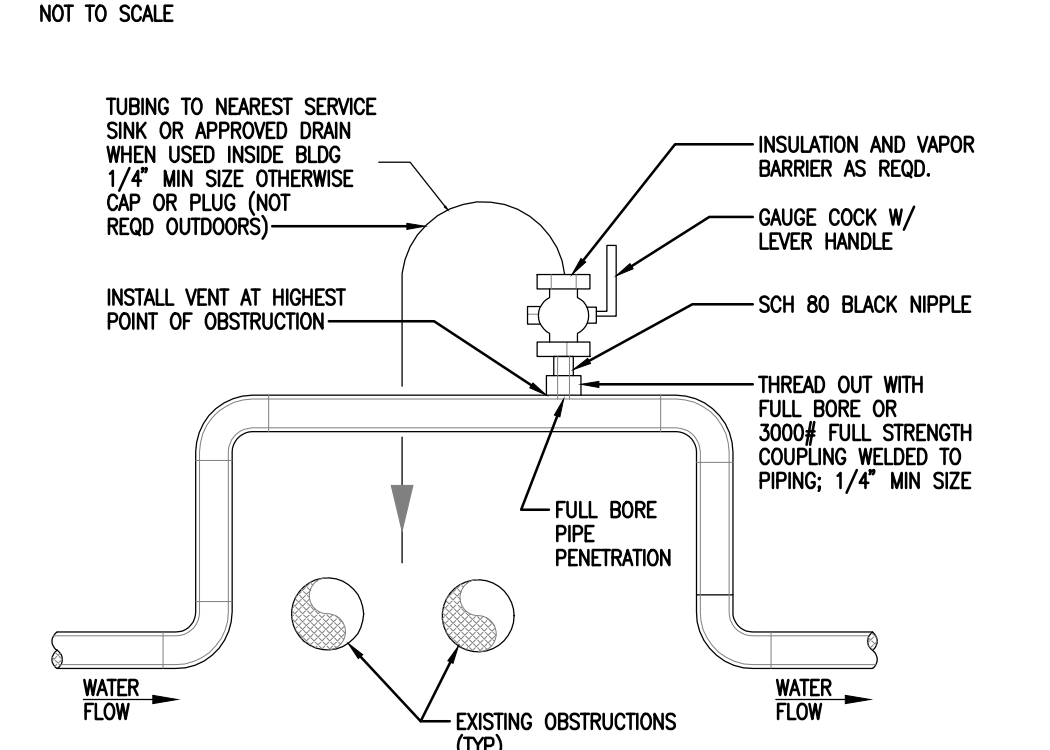

HIGH POINT MANUAL AIR VENT
NOT TO SCALE

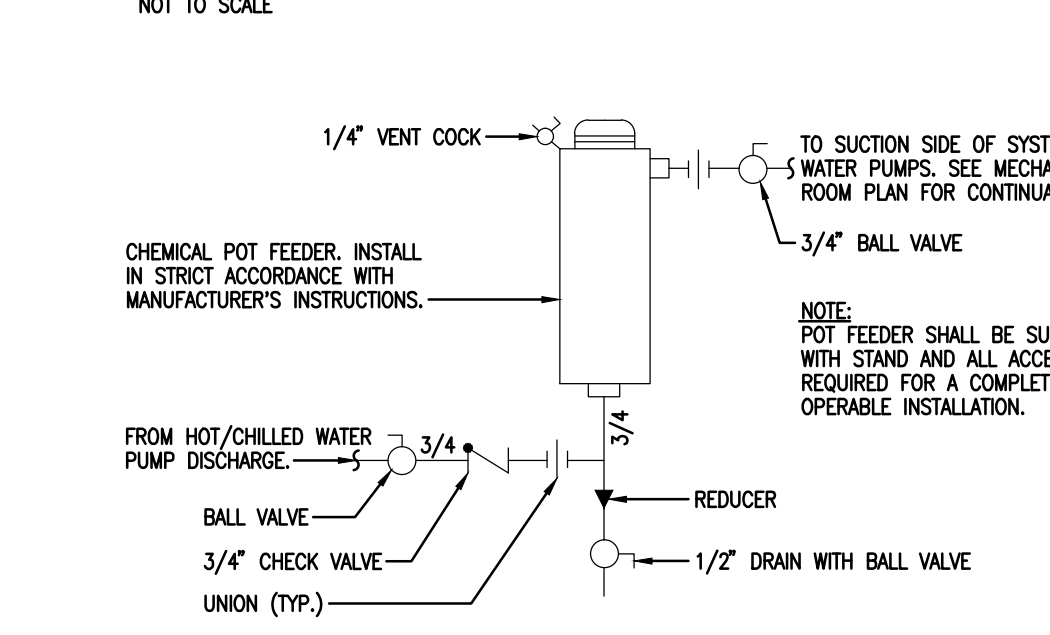

POT FEEDER PIPING DETAIL
NOT TO SCALE

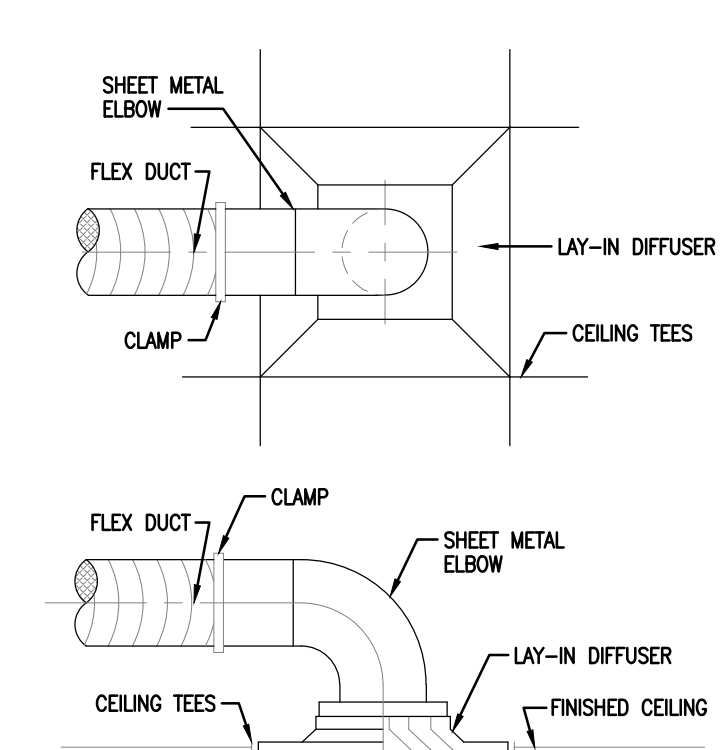

ROUND NECK DIFFUSER DETAIL
NOT TO SCALE

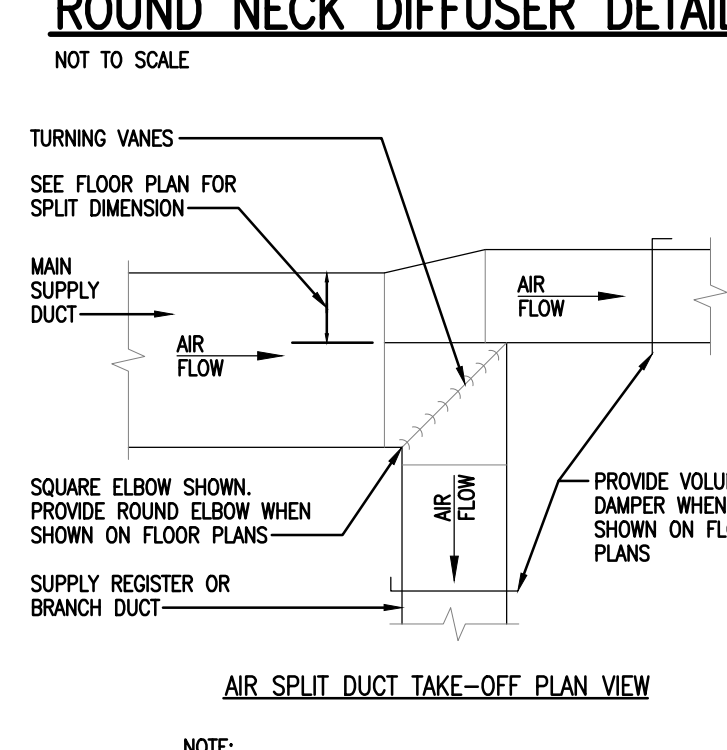

TYPICAL DIFFUSER RUNOUT DETAIL
NOT TO SCALE

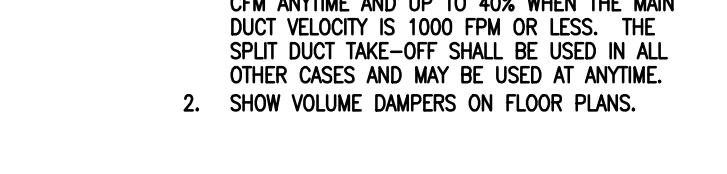

SUPPLY DUCTWORK TAKE-OFFS
NOT TO SCALE

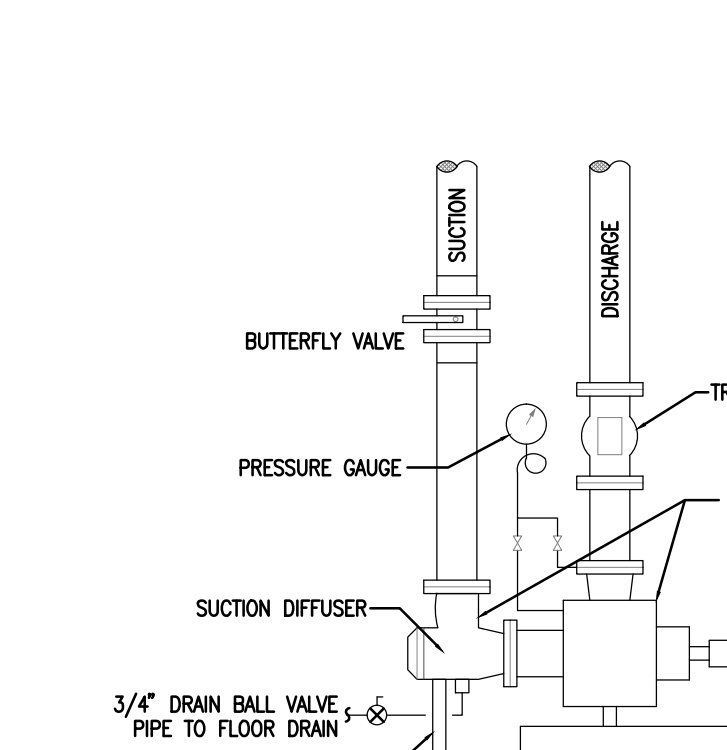

TYPICAL BASE MOUNTED PUMP SCHEMATIC
NOT TO SCALE

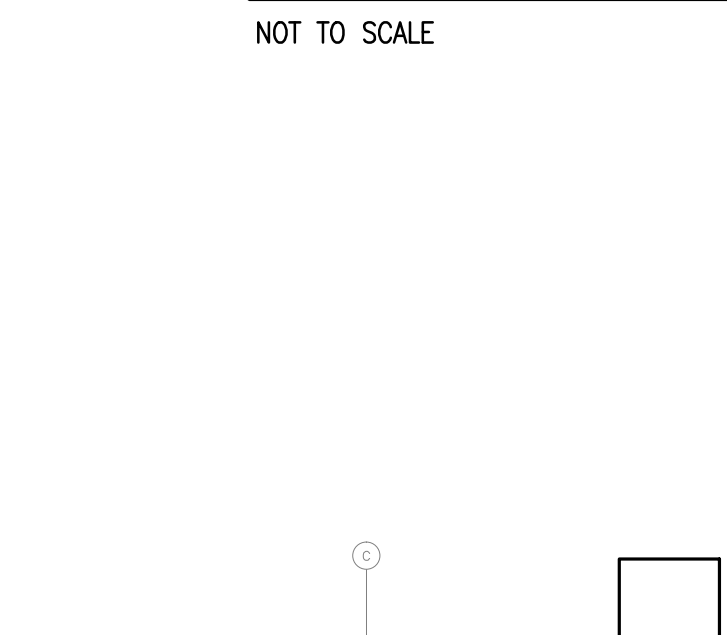

THERMOMETER AND THERMOWELL INSTALLATION
NOT TO SCALE

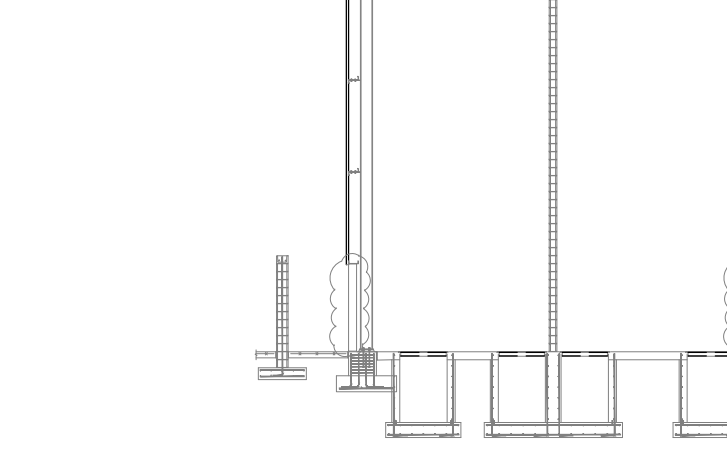

GAUGE COCK INSTALLATION
NOT TO SCALE

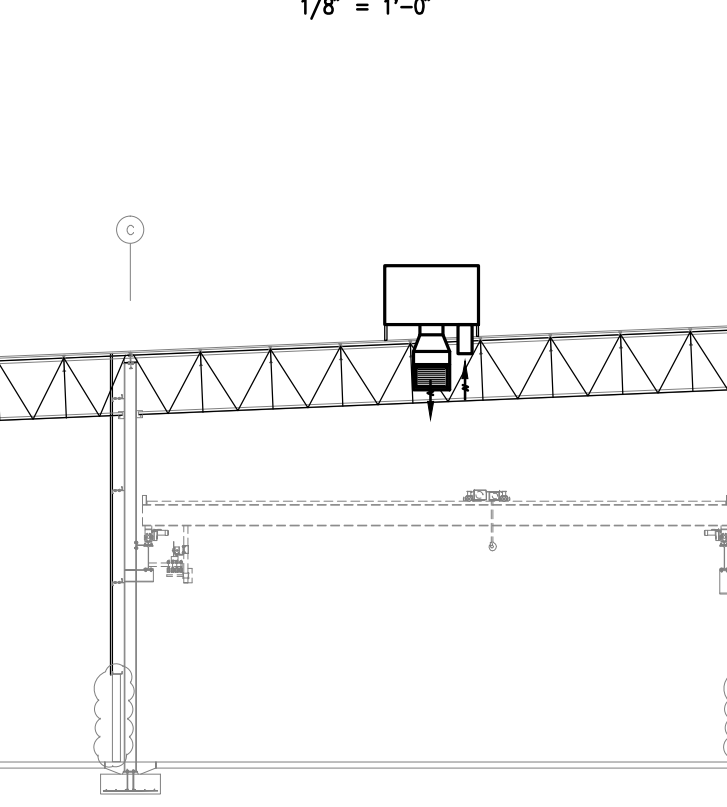

HVAC SECTION - PACKAGING AND SHIPPING AREA
1/8" = 1'-0"

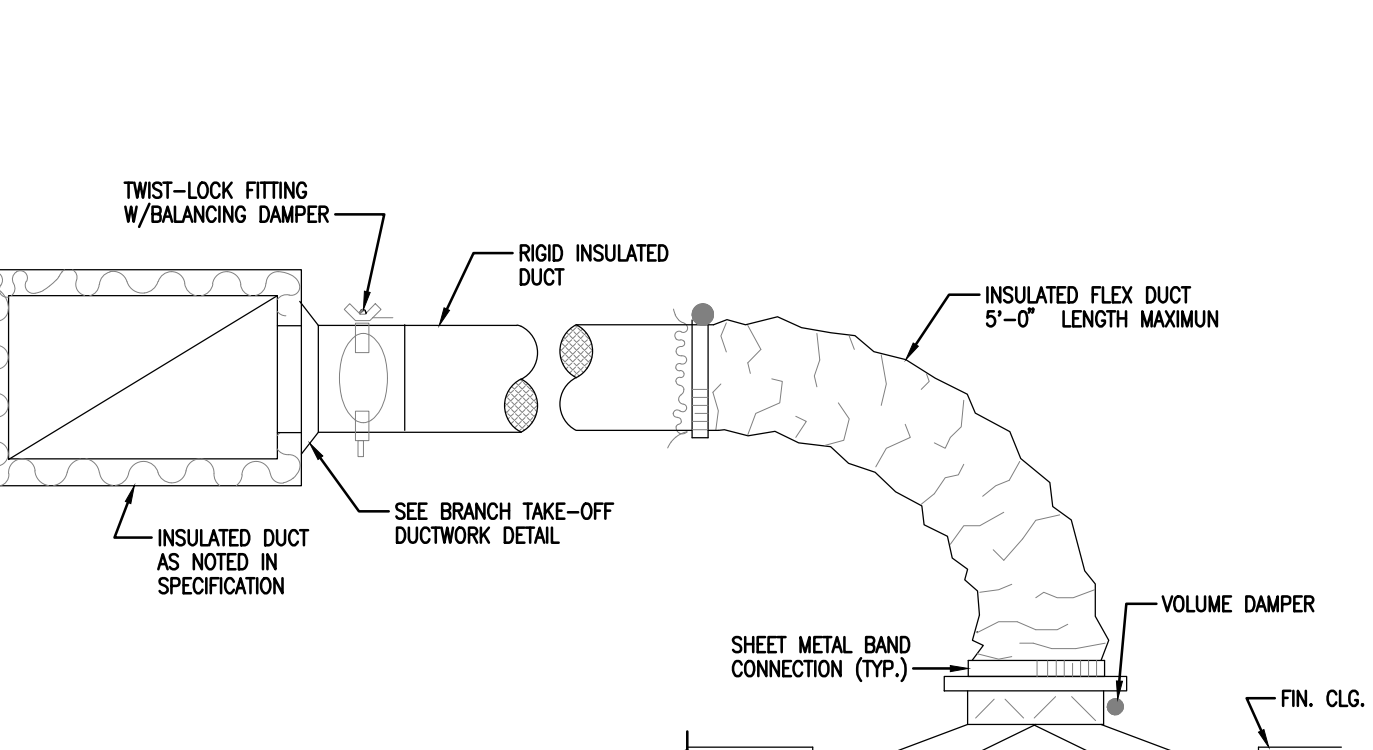

TYPICAL DUCT HANGER
NOT TO SCALE

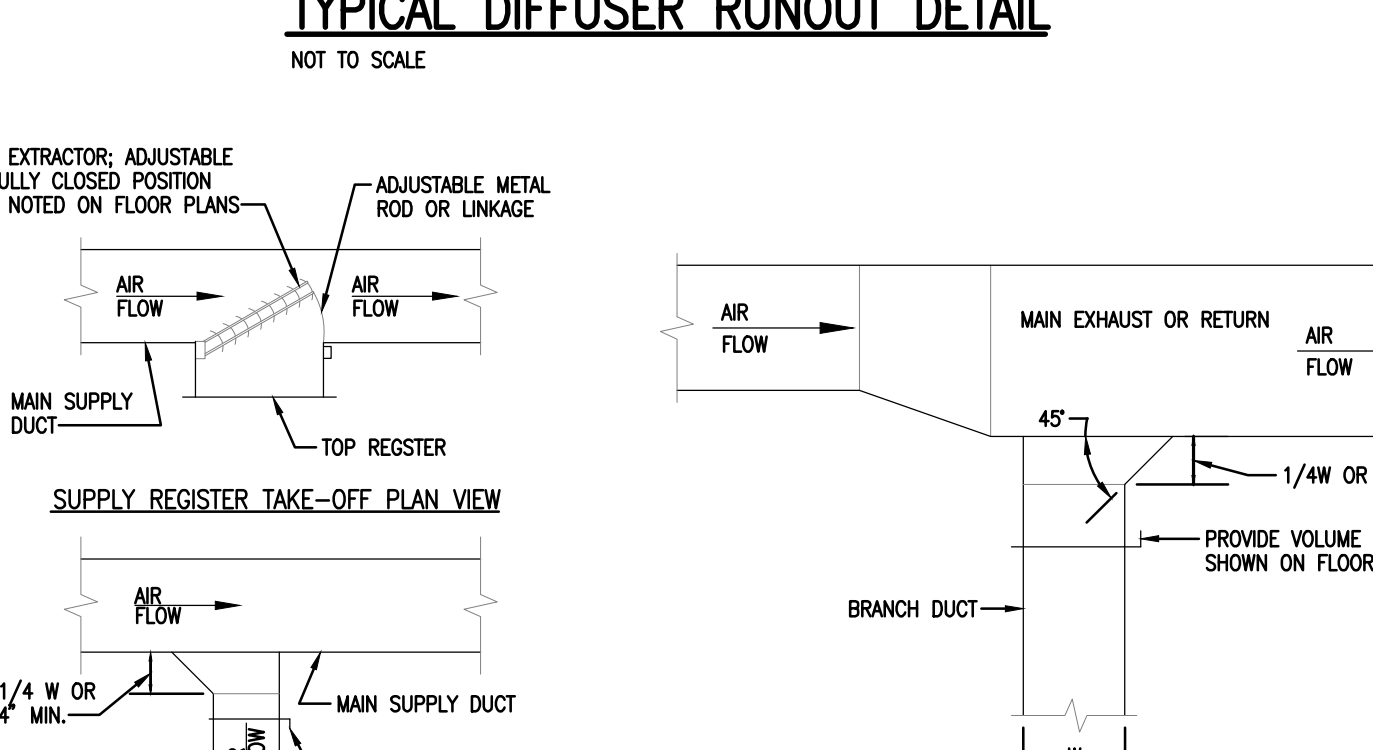

TYPICAL DIFFUSER RUNOUT DETAIL
NOT TO SCALE



EXHAUST OR RETURN BRANCH DUCTWORK
NOT TO SCALE

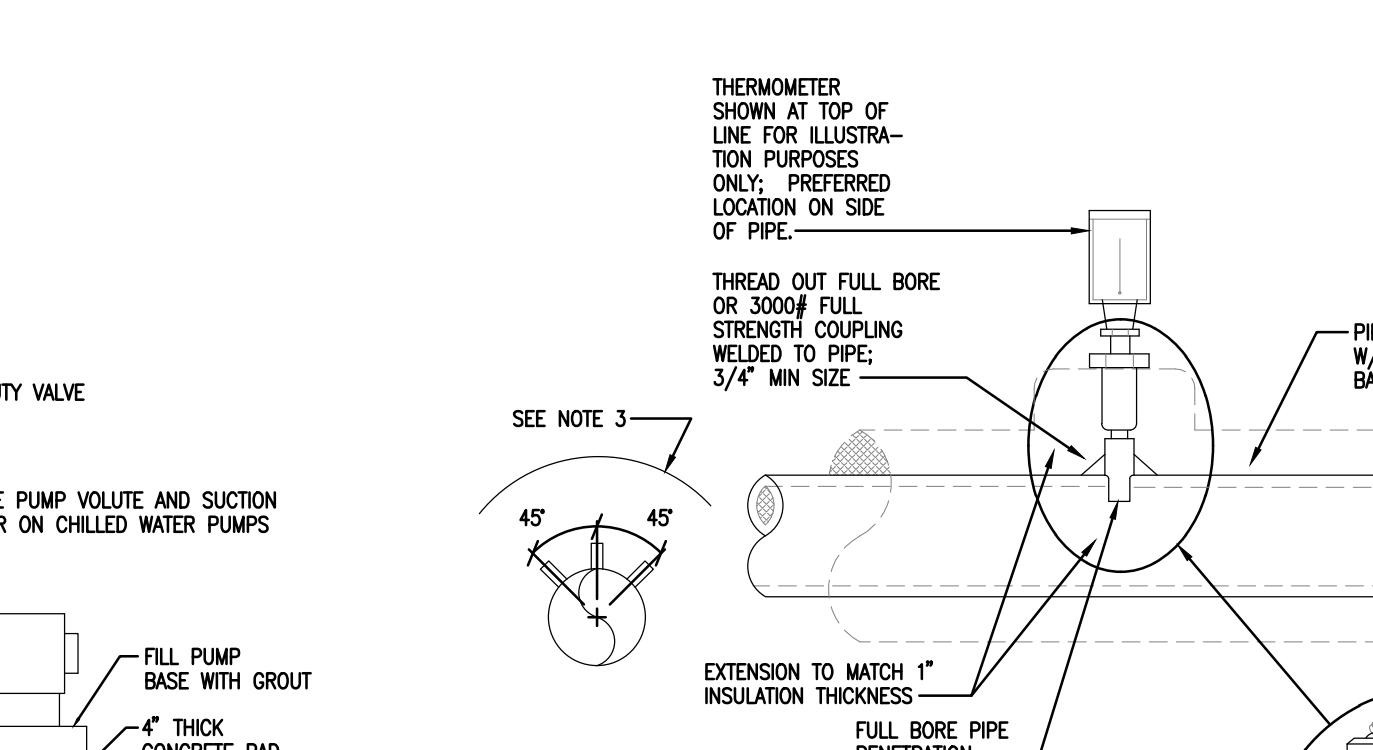

SPIDER TYPE PIPE ALIGNMENT GUIDE
NOT TO SCALE

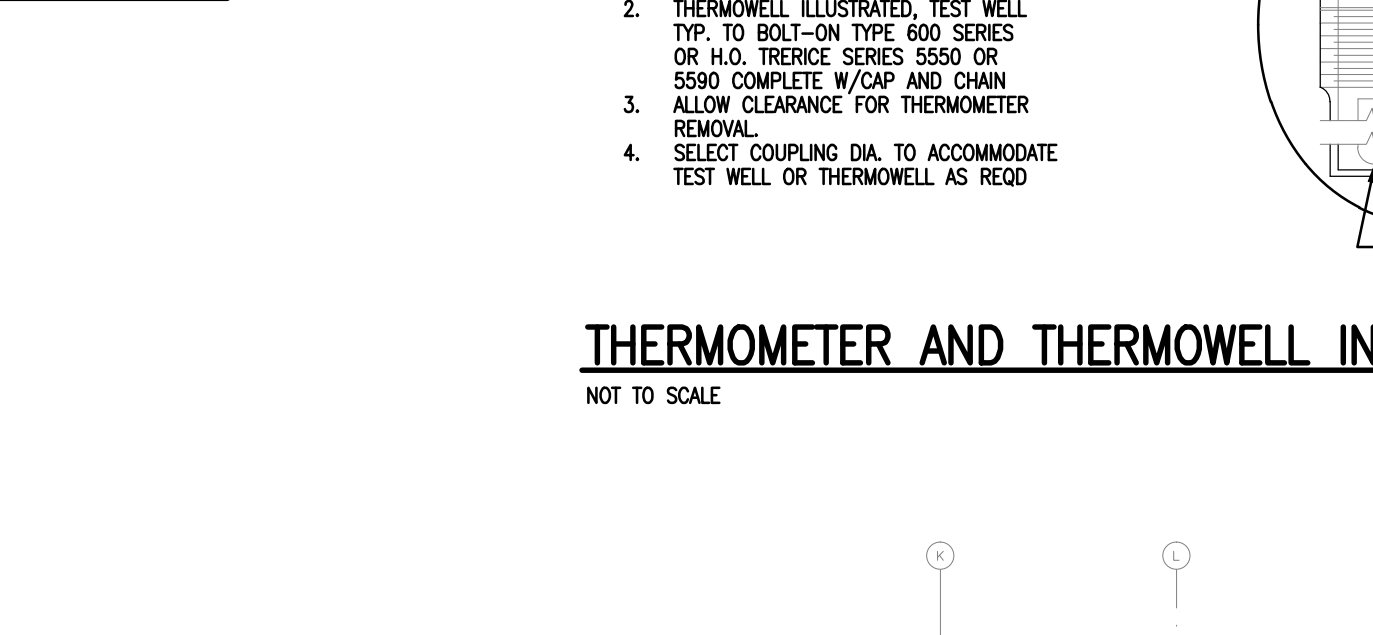

TYPE 33 T-BAR MOUNTED PIPE SLIDE WITH WELDED GUIDE OR CLAMP BASE
NOT TO SCALE

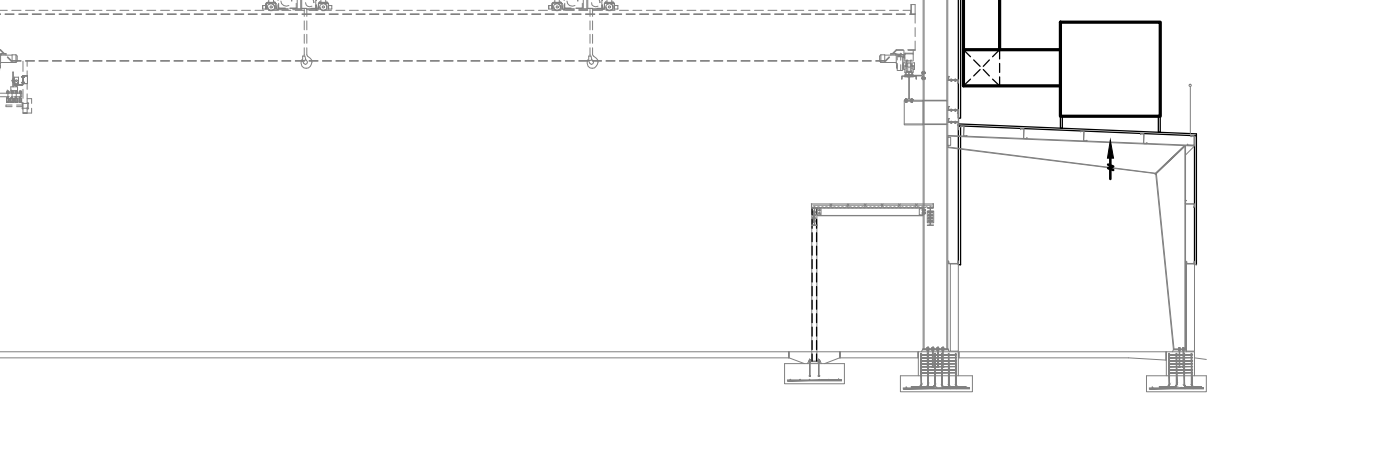

PIPE PENETRATION THRU CONCRETE
NOT TO SCALE

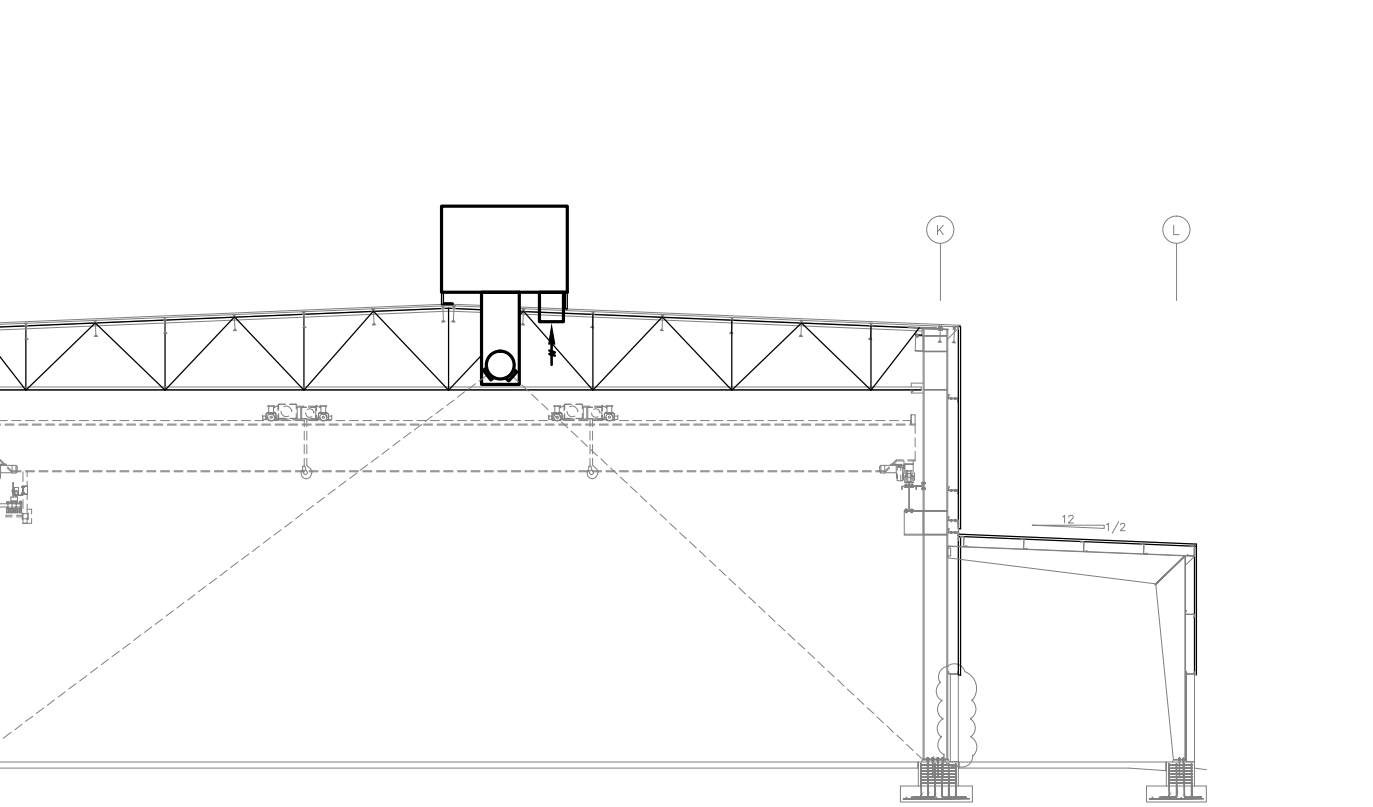

CHILLER W/ REMOTE EVAPORATOR INSTALLATION DETAIL
NOT TO SCALE

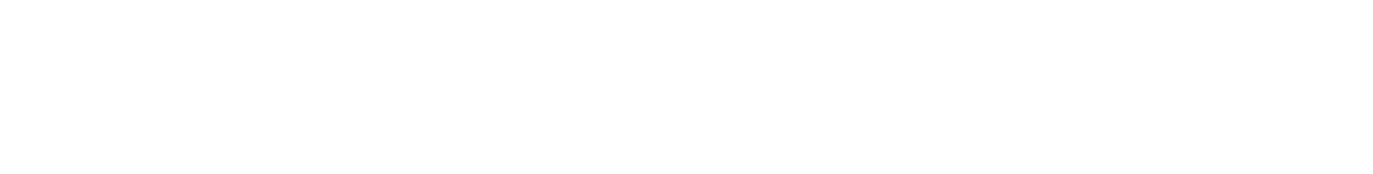

PACKAGED CHILLER INSTALLATION DETAIL
NOT TO SCALE

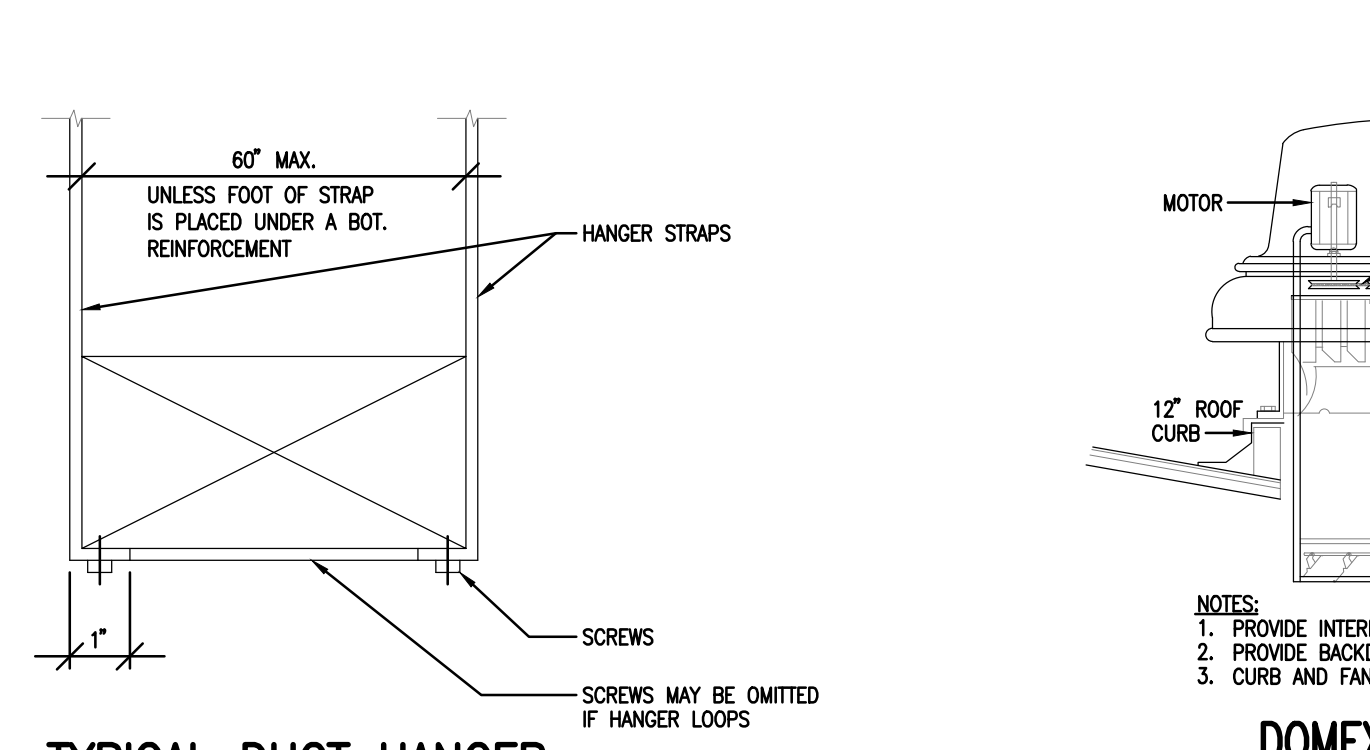

DOMEX TYPE CENTRIFUGAL ROOF EXHAUSTER
NOT TO SCALE

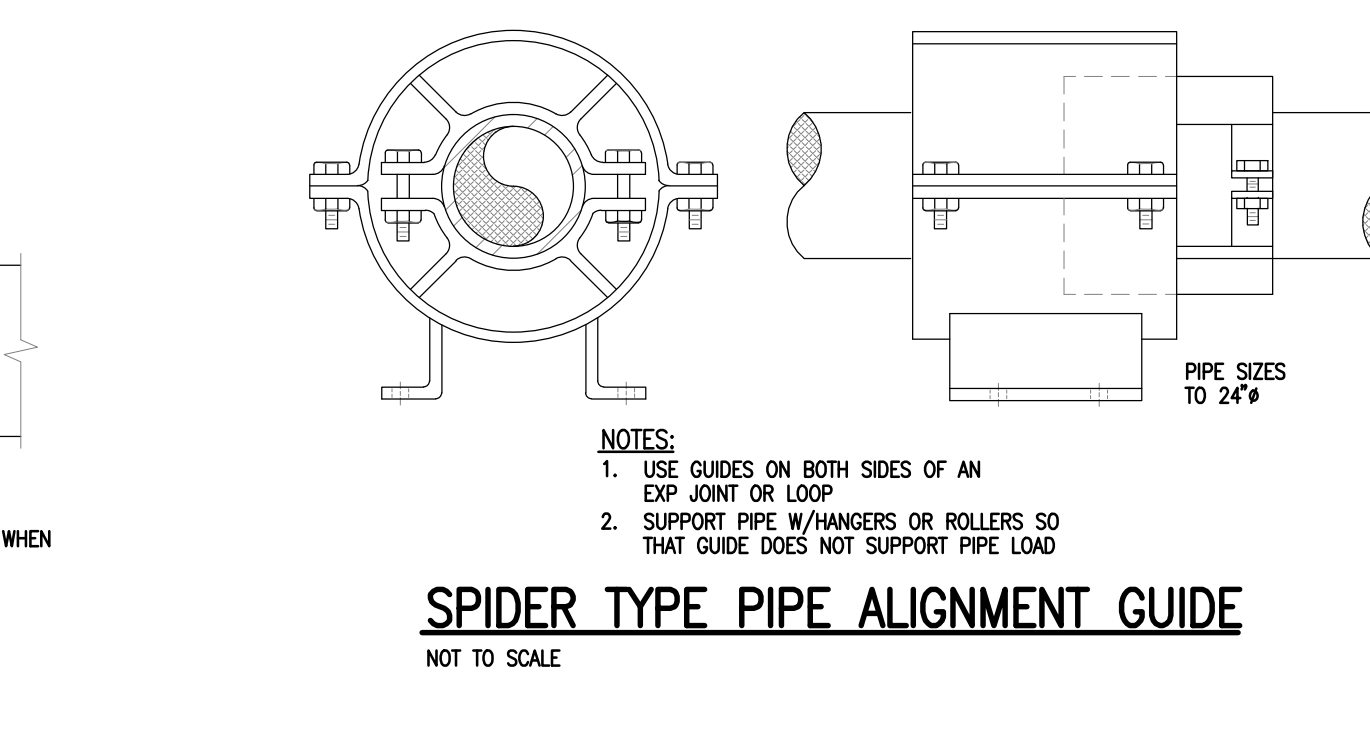

CHILLED WATER PIPE SUPPORT DETAIL
NOT TO SCALE

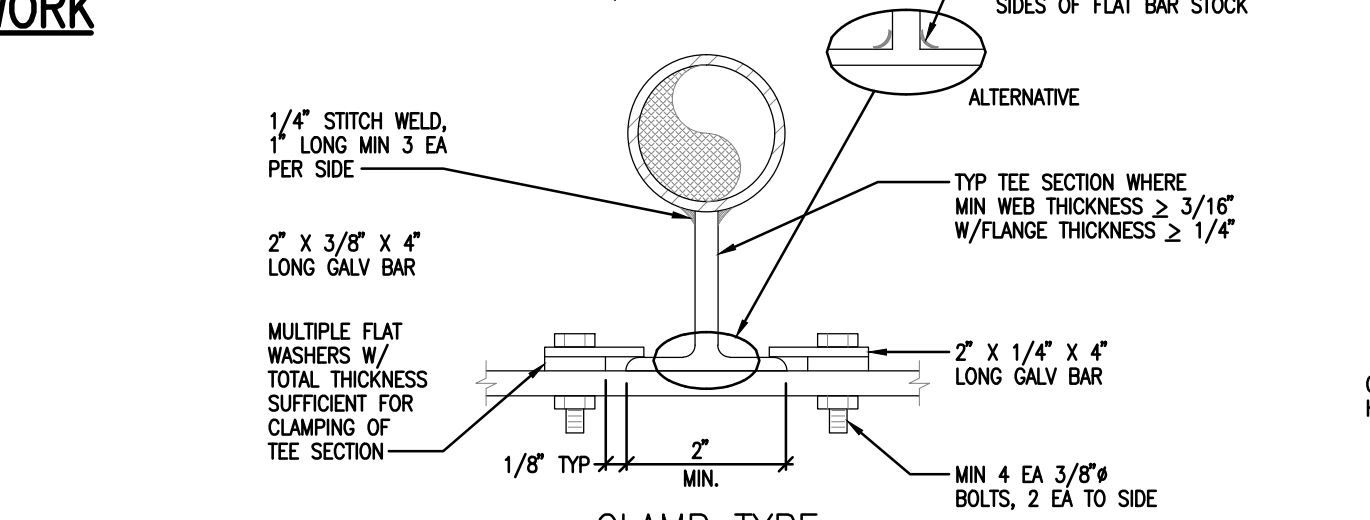

TYPICAL SUSPENSION FROM SLAB DETAIL FOR CW PIPES UP TO 2"
NOT TO SCALE

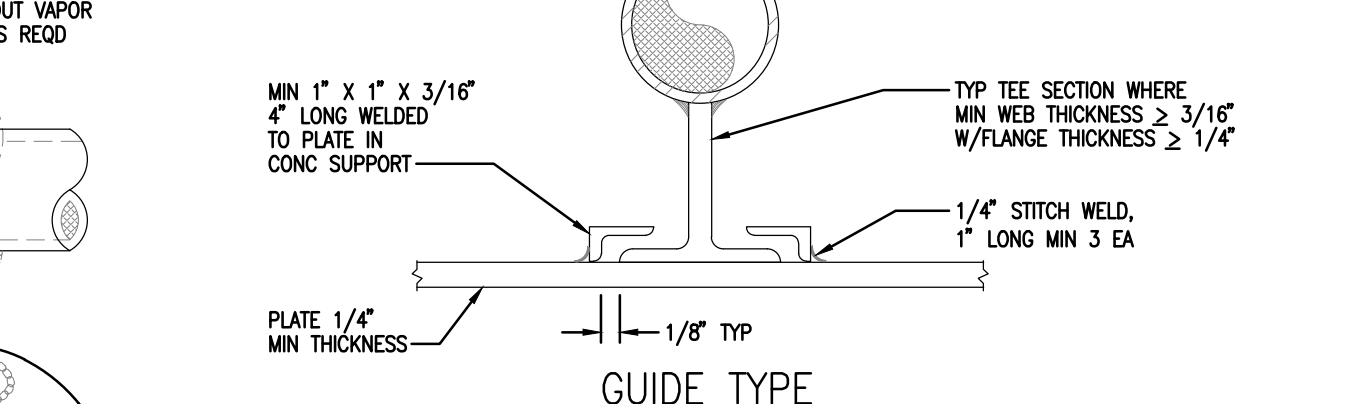

GRID HORIZONTAL MOUNTING DETAIL FOR CW PIPES 4" TO 8" PIPE INSIDE BUILDING
NOT TO SCALE

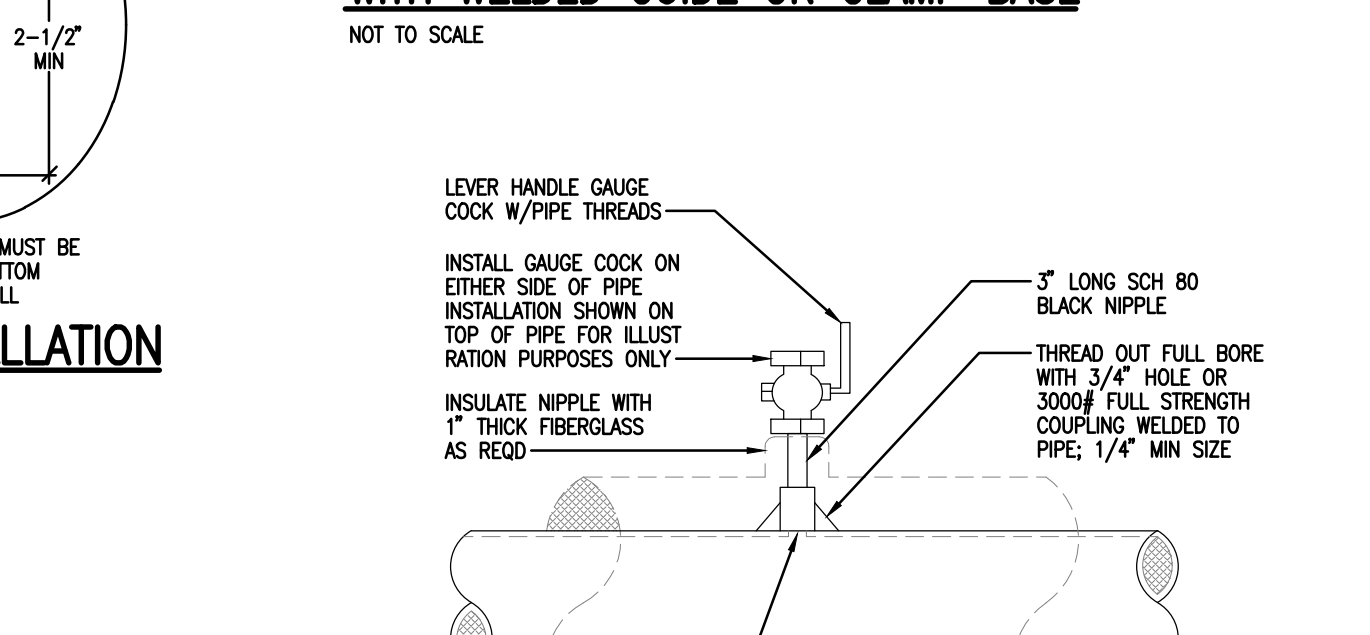

PIPE IN TRENCH DETAIL
NOT TO SCALE

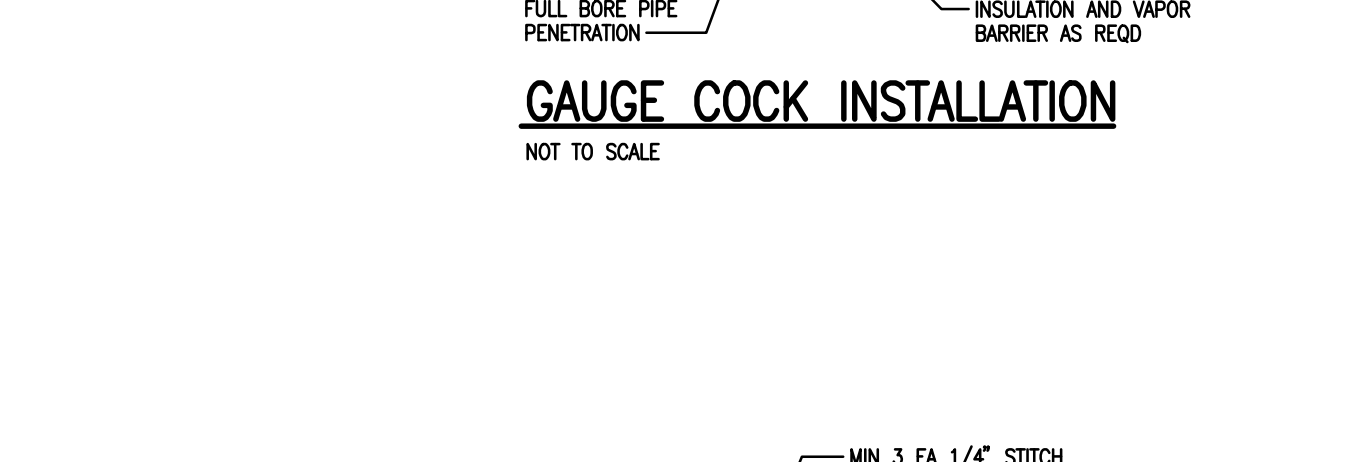

TYPICAL PROCESS EQUIPMENT CONNECTION DETAIL
NOT TO SCALE

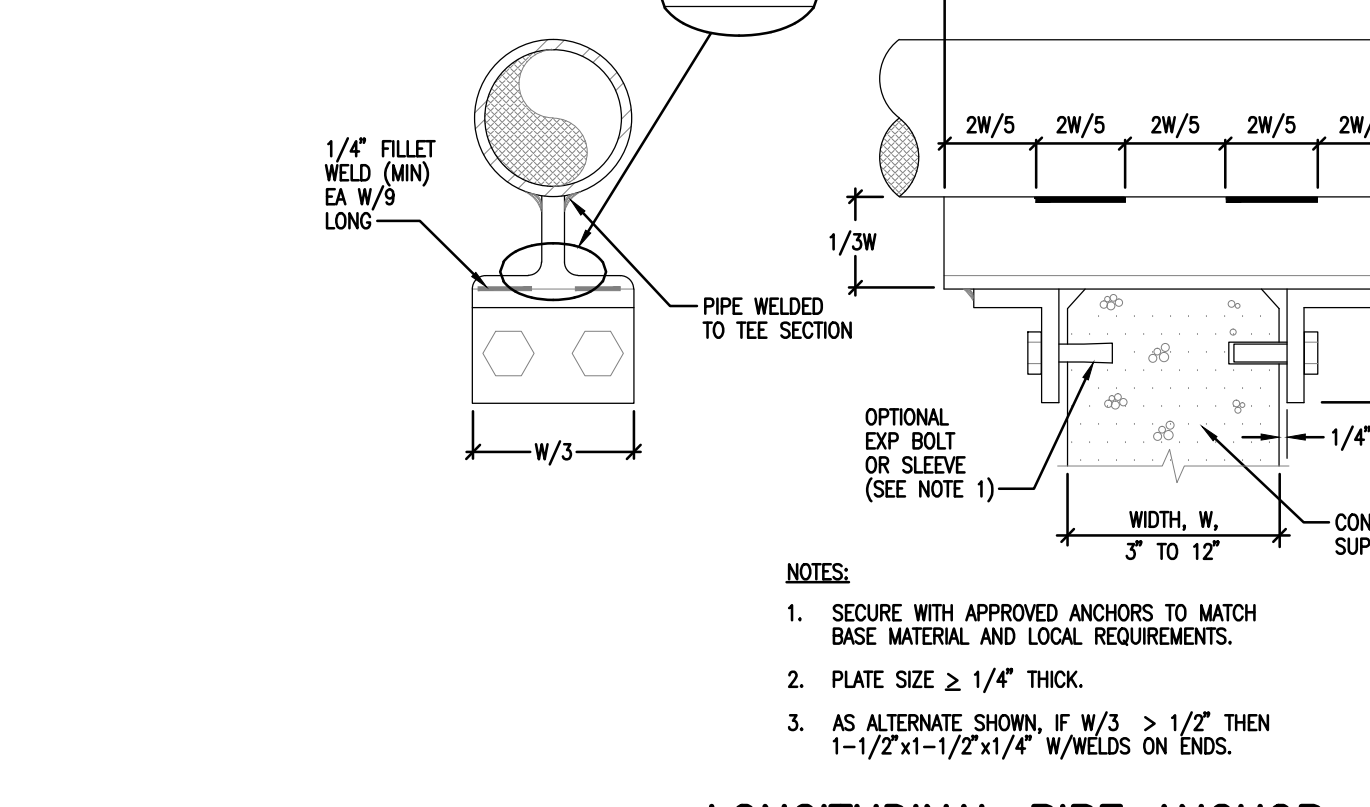

LONGITUDINAL PIPE ANCHOR
NOT TO SCALE

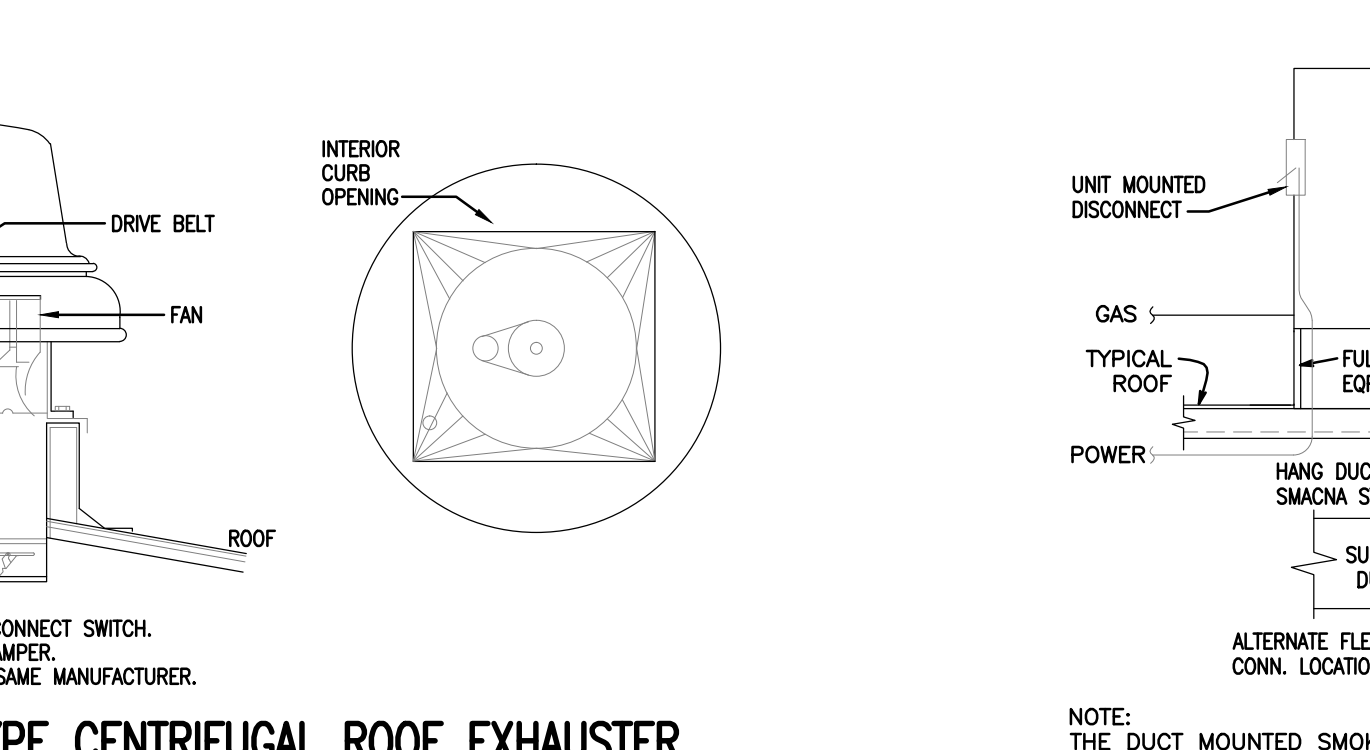

TYPICAL ROOFTOP UNIT INSTALLATION
N.T.S.

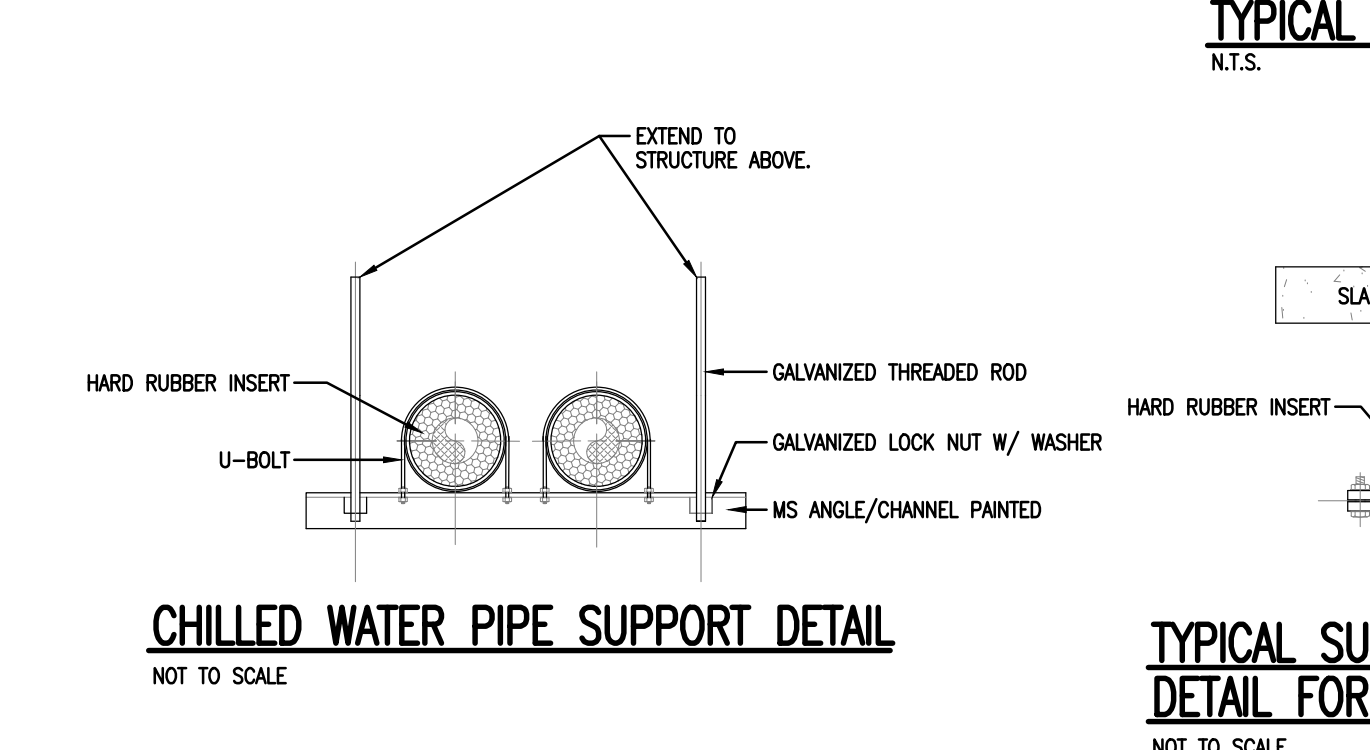

TYPICAL SUSPENSION FROM SLAB DETAIL FOR CW PIPES UP TO 2"
NOT TO SCALE

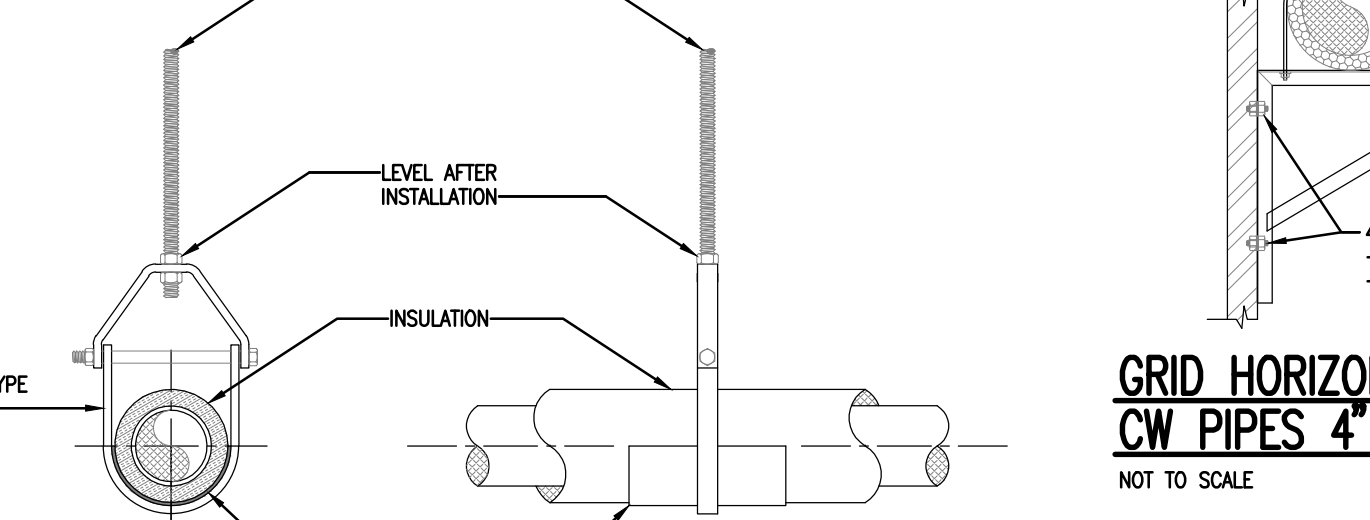

PIPE IN TRENCH DETAIL
NOT TO SCALE

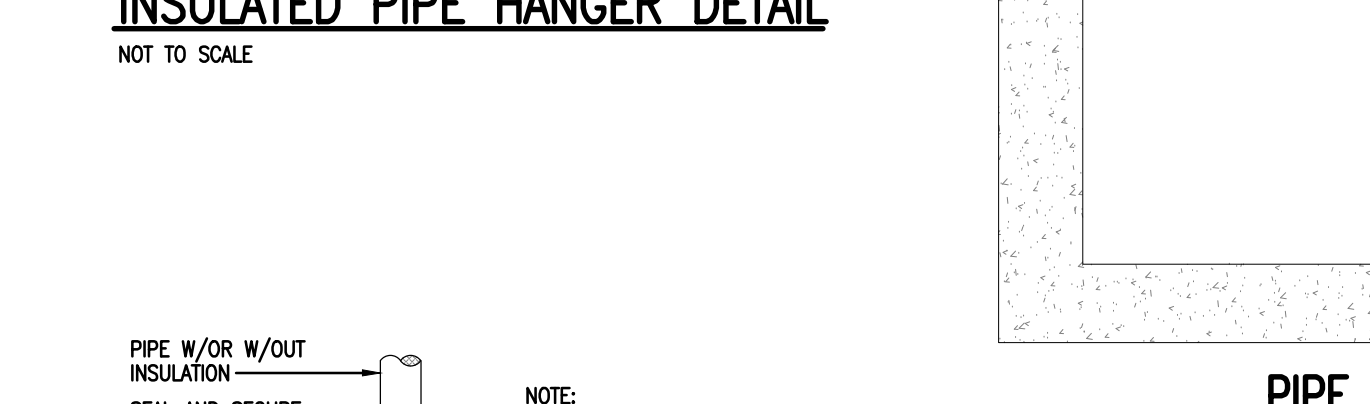

TYPICAL PROCESS EQUIPMENT CONNECTION DETAIL
NOT TO SCALE

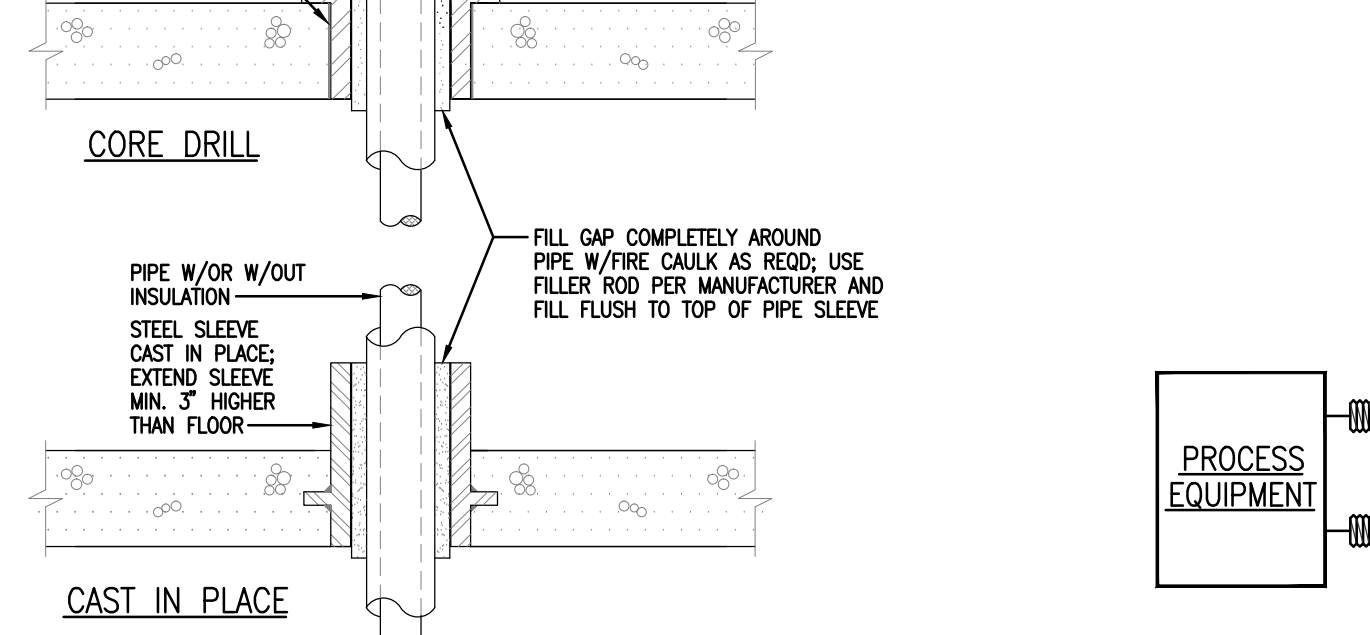

LONGITUDINAL PIPE ANCHOR
NOT TO SCALE

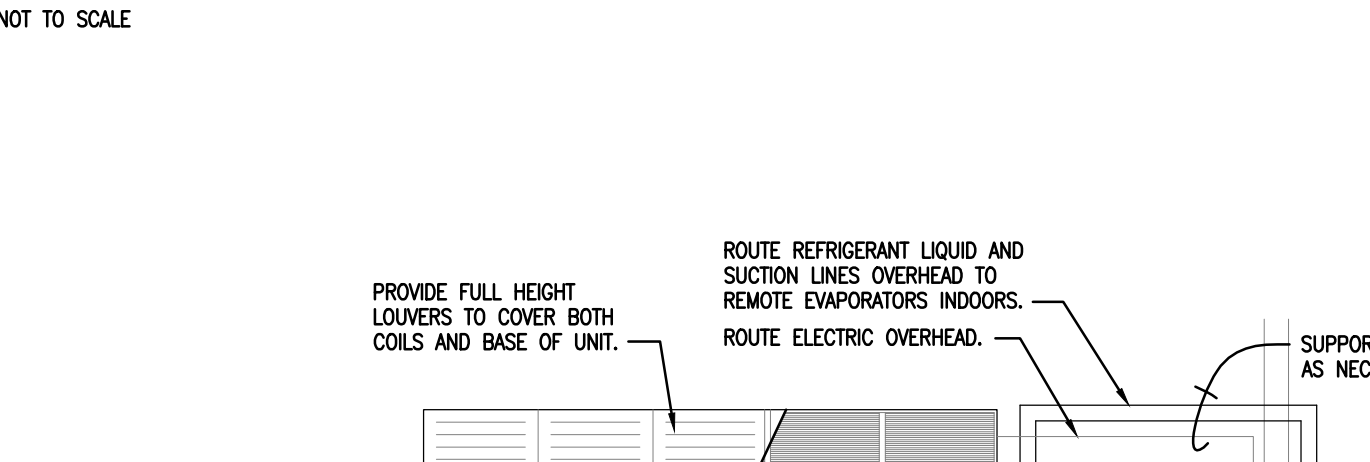

CHILLER W/ REMOTE EVAPORATOR INSTALLATION DETAIL
NOT TO SCALE

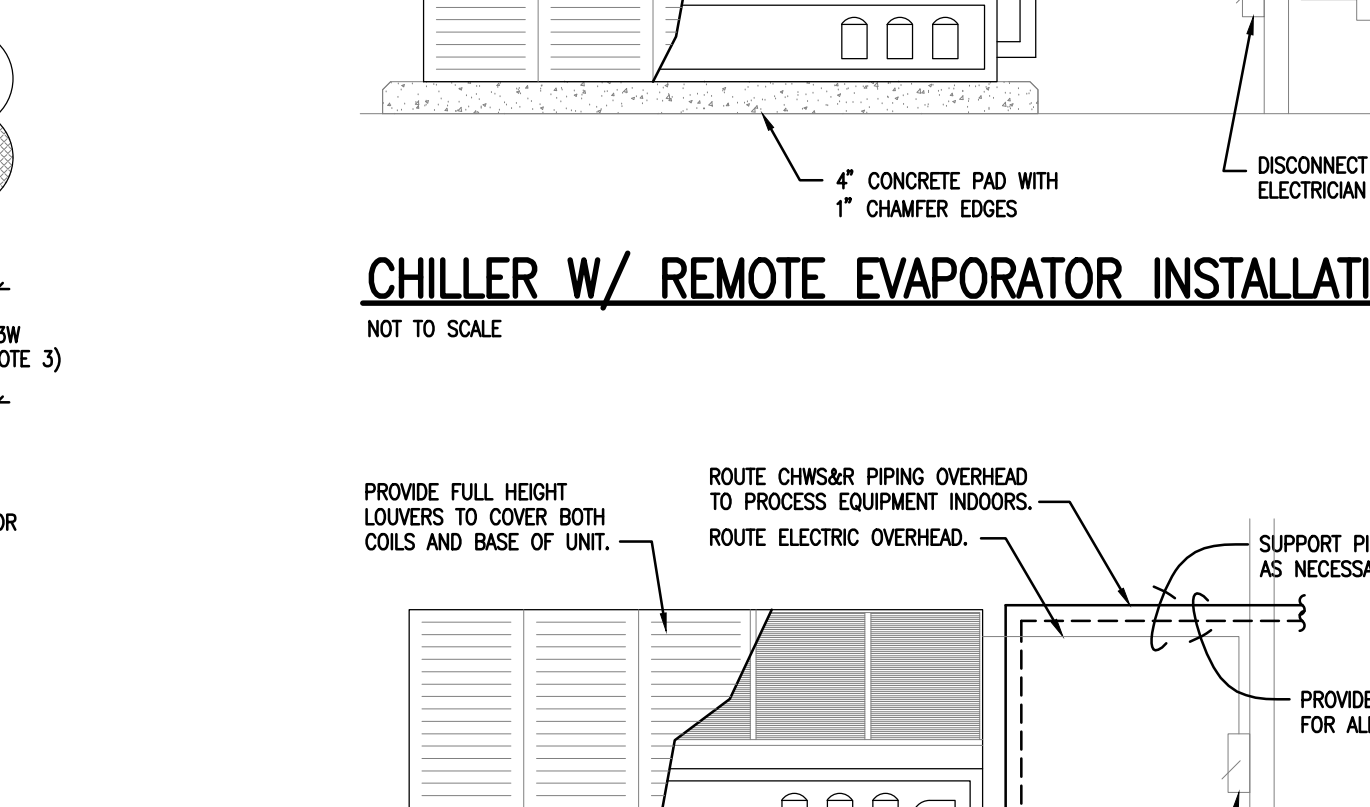

PACKAGED CHILLER INSTALLATION DETAIL
NOT TO SCALE

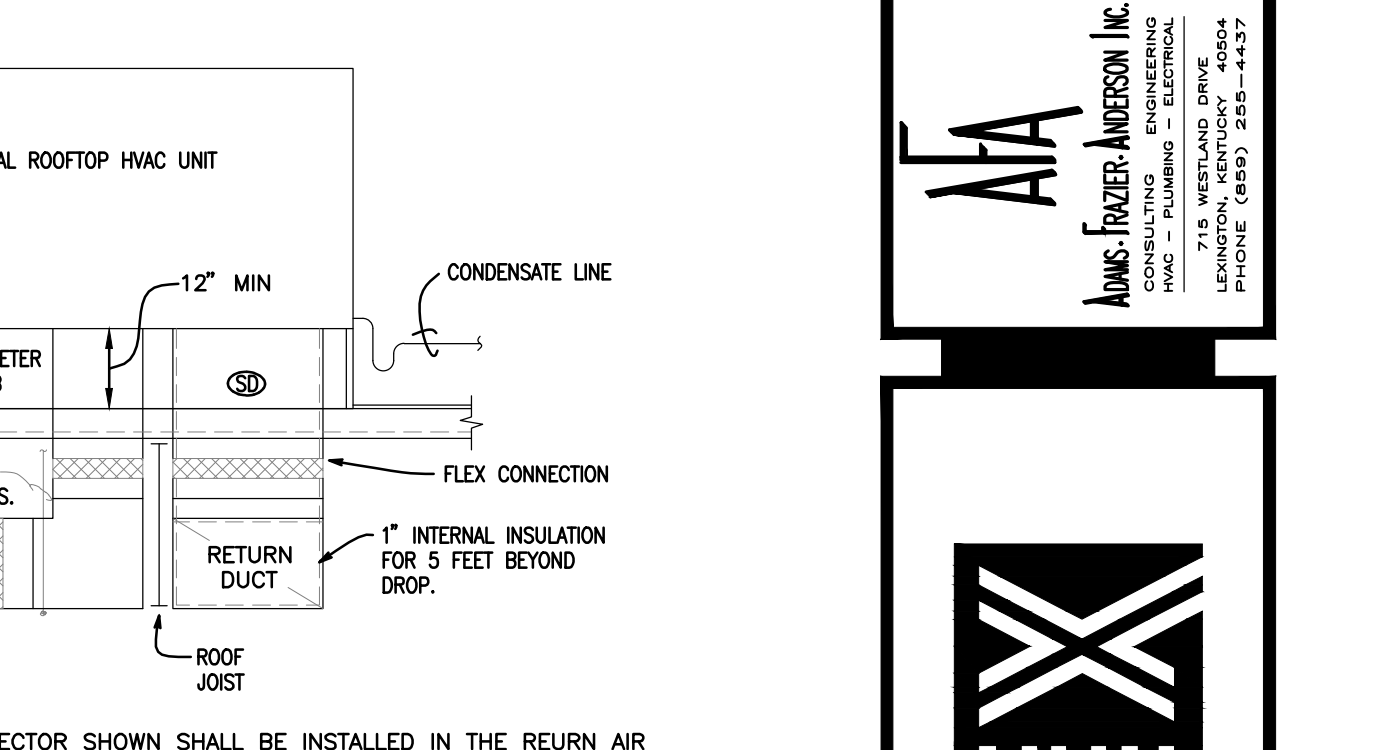

DOMEX TYPE CENTRIFUGAL ROOF EXHAUSTER
NOT TO SCALE



CHILLED WATER PIPE SUPPORT DETAIL
NOT TO SCALE

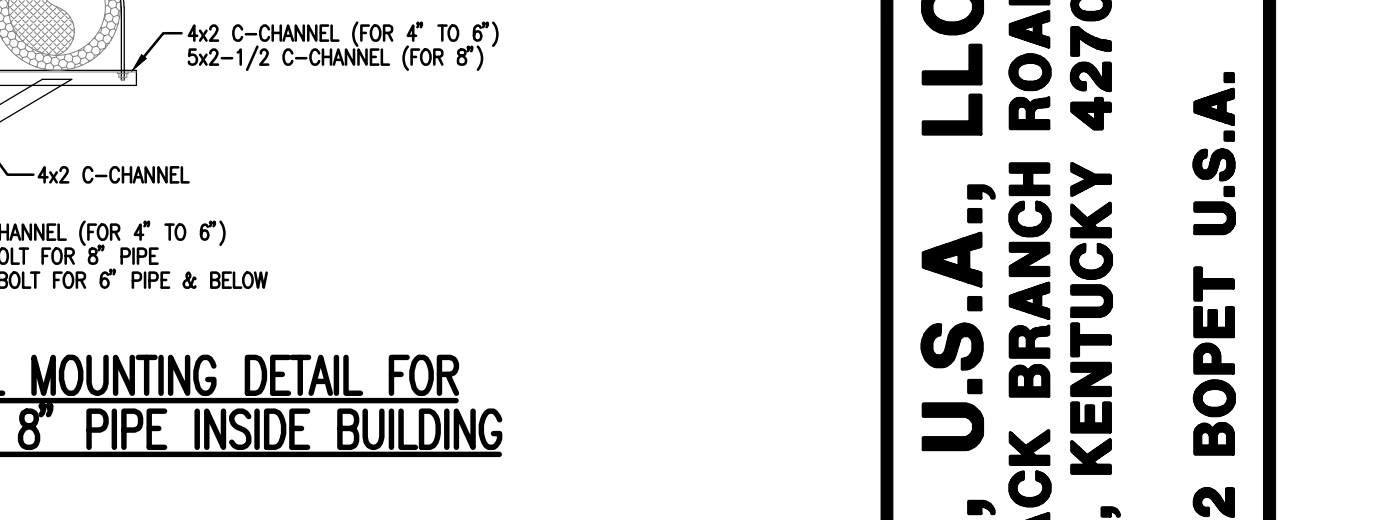

TYPICAL SUSPENSION FROM SLAB DETAIL FOR CW PIPES UP TO 2"
NOT TO SCALE

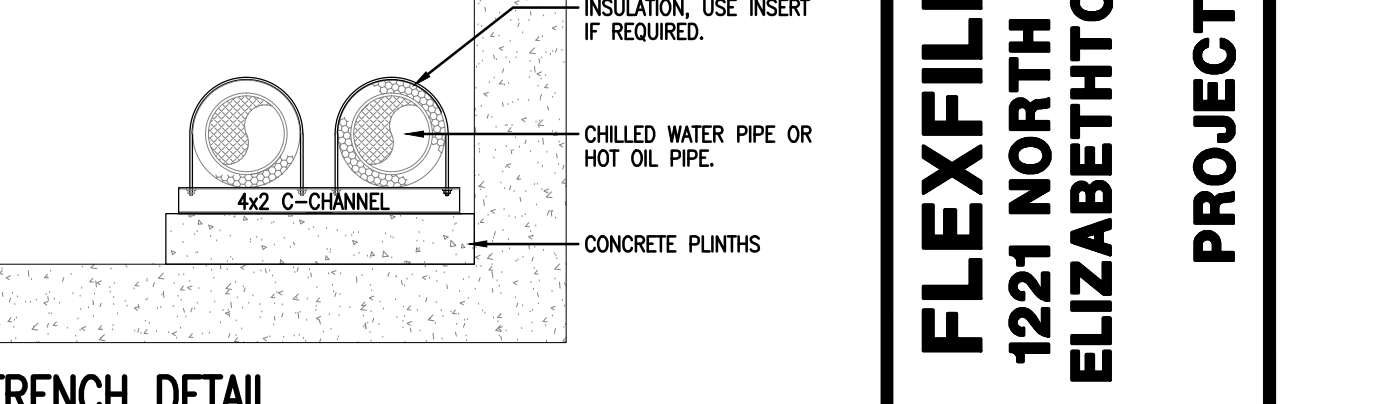

PIPE IN TRENCH DETAIL
NOT TO SCALE

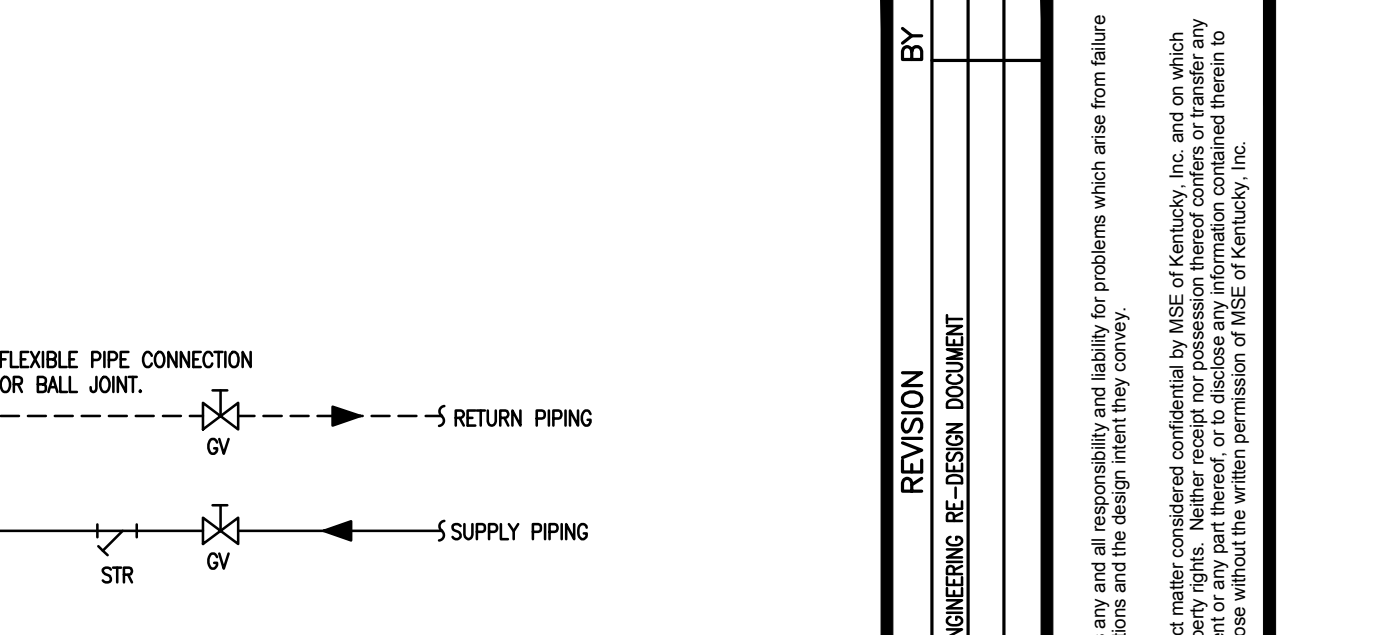

TYPICAL PROCESS EQUIPMENT CONNECTION DETAIL
NOT TO SCALE

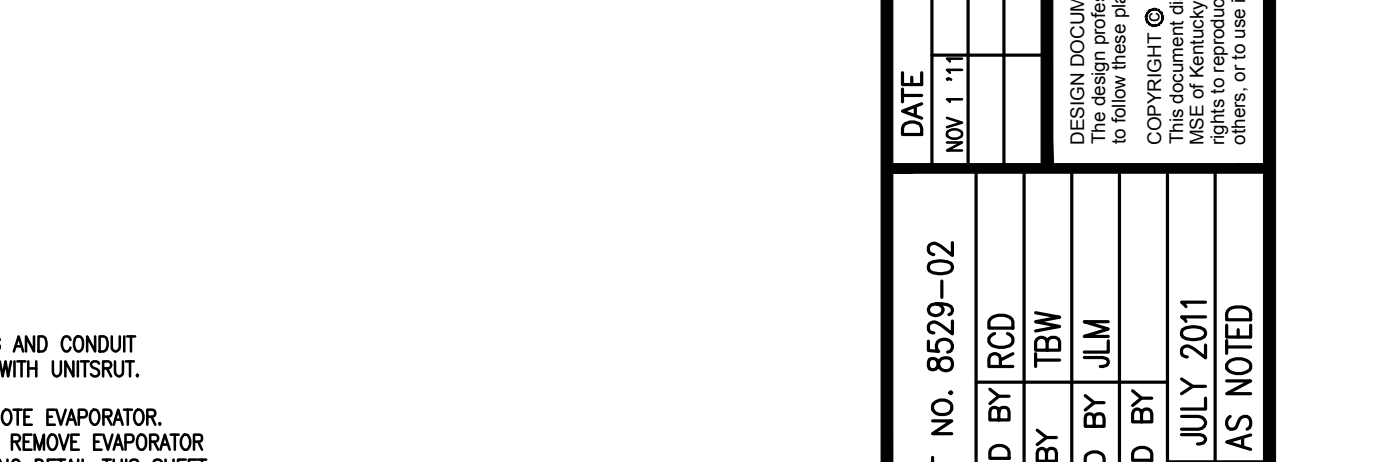

LONGITUDINAL PIPE ANCHOR
NOT TO SCALE

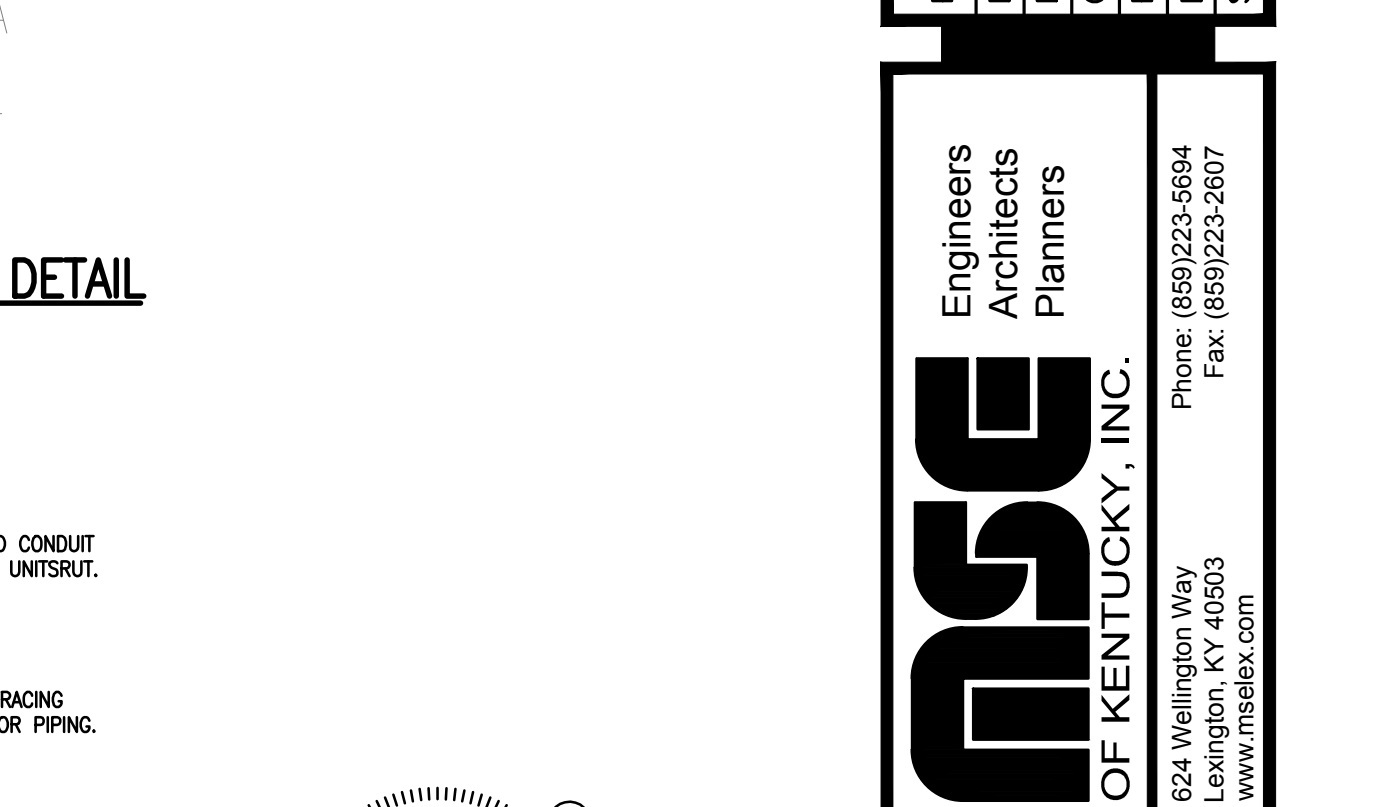

CHILLER W/ REMOTE EVAPORATOR INSTALLATION DETAIL
NOT TO SCALE



PACKAGED CHILLER INSTALLATION DETAIL
NOT TO SCALE

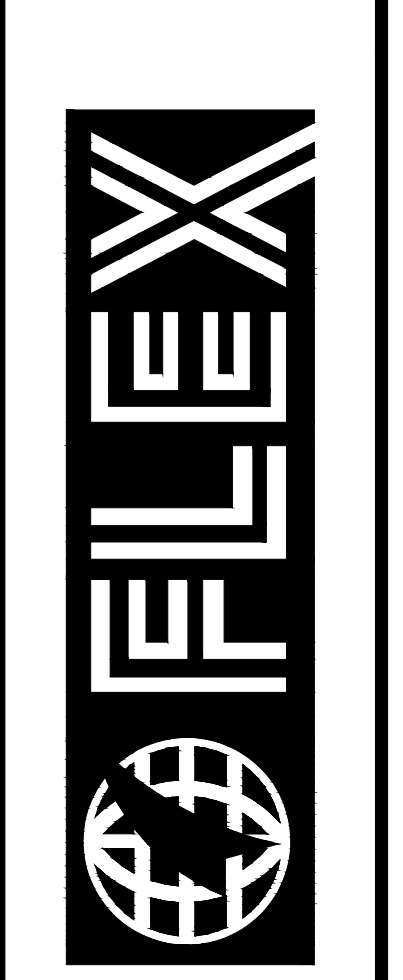
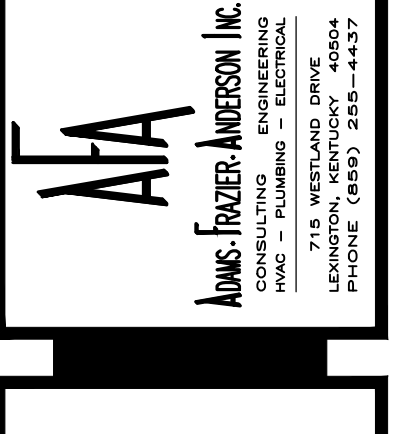

FLEXFILMS, U.S.A., LLC
1221 NORTH BLACK BRANCH ROAD
ELIZABETHTOWN, KENTUCKY 42702
PROJECT L-12 BOPET U.S.A.

DATE	REVISION	BY
NOV. 11, 2011	VALUE ENGINEERING RE-DESIGN DOCUMENT	

PROJECT NO. 8529-02	DESIGNED BY RCD	DATE
DRAWN BY TBW	CHECKED BY JLM	NOV. 11, 2011
REVIEWED BY	DATE	JULY 2011
SCALE	AS NOTED	

MS&E OF KENTUCKY, INC.
Engineers
Architects
Planners
624 Wellington Way
Lexington, KY 40503
Phone: (859) 223-5664
Fax: (859) 223-5607
www.msae.com

DRAWING NO.
UFL-L12 M-007